

Hill Air-Flex Table

Owner's Manual



Quality and Innovation Since 1945.

Congratulations!

And welcome to the Hill Laboratories family.

Hill Laboratories has been making quality a family business since 1945. Your new Air-Flex is built on an established Hill tradition of innovation and value. Our reputation rests on the confidence that *your* Hill Table will strengthen this legacy by providing you with solid, reliable service for many years to come.

At Your Service

The Hill Laboratories Guarantee.

Your Hill Laboratories table has been thoroughly tested and inspected before shipment. All parts are guaranteed against defect in materials for one full year from the date of purchase. During this period, any such defect will be remedied by Hill Laboratories or by a factory-authorized repair service at no charge. Tables damaged by mishandling or accident will be repaired at a reasonable charge. All correspondence should be directed to your local dealer, or when this is not possible, to Hill Laboratories directly.

For tables beyond the warranty period, our service technicians are standing by to serve you. They can be reached toll-free at 1-877-445-5020 from 9 am - 5 pm E.S.T., Monday through Friday. After hours, please leave your name, phone number and a brief description of your concern. Your call will be returned promptly the next business day.

We appreciate your business and your confidence in our products. Our aim is to provide you with excellent service and satisfaction for many years to come.

A handwritten signature in black ink that reads "Howard D. Hill". The signature is written in a cursive style and is positioned above the printed name of the president.

President, Hill Laboratories

Hill Air-Flex Manual

Table of Contents

Product Features

Basic Table Components _____	1.1
Specifications _____	1.2

Table Care

Cleaning your Table _____	2.1
Caution and Symbol Explanation _____	2.2

Basic Table Operation

Preparing the Air-Flex for your Patient _____	3.1
Height Pedal _____	3.2
The Control Panel _____	3.3
Manual Thoracic Release/Thoracic Air-Breakaway _____	3.4
Basic Distraction _____	3.5
Basic Flexion (Balancing the Patient) _____	3.6

Using the Rotation Lock

Using the Rotation Feature _____	4.1
Returning the Rotation Feature to the Horizontal Position _____	4.2

Using Air-Drops

Drop Selector Switches _____	5.1
------------------------------	-----

Headpieces

Tilting Headpiece _____	6.1
Dual Drop Headpiece _____	6.2
Raised Headpiece _____	6.3
Cervical Flexion Headpiece _____	6.4
Translation/CBP Headpiece _____	6.5

Instructions for the Auto-Flexion Option

The Auto-Flexion Touchscreen _____	7.1
Switching to Auto-Flex _____	7.2

Instructions for the Auto-Distraction Option

The Auto-Distraction Touchscreen _____	8.1
Manual/Auto Mode _____	8.2
Cervical Auto-Distraction _____	8.3

Trouble Shooting _____	Pages 16-17
-------------------------------	-------------

Wiring Diagrams _____	Pages 18-20
------------------------------	-------------

Index of Terms _____	Pages 21-22
-----------------------------	-------------

Product Features

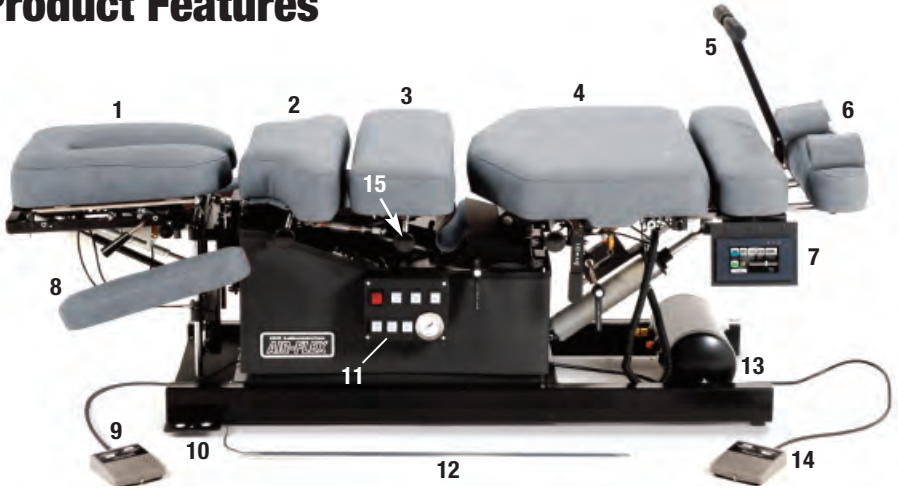

1.1 Basic Table Components and Options

1. Tilting Headpiece. May include several options
2. Thoracic Drop with Thoracic Release/Breakaway
3. Lumbar Drop
4. Pelvic Drop / Rotation and Lateral Flexion with locking mechanisms
5. Removable Flexion Tiller Bar
6. Slide-out Ankle Support with Ankle Harnesses
7. LCD Touchscreen Control (optional)
8. Armrest
9. Corded Height Pedal
10. Optional Rocker Foot Pedal
11. Power and Air-Drop Control Panel
12. Power Foot Strips for activating Air-Drops (optional)
13. Air Tank
14. Air-Pressure Foot Pedal
15. Drop-Tension Control Knobs

1.2 Specifications

- Electric requirement 60 Hz, 115 v~, 4.8 A or 220-50 cycle
- Lifting capacity - 450 pounds
- Acrylic thermo-plastic base
- Ultra-Cell® foam for comfort and shape retention
- Height Range - 21 $\frac{1}{2}$ "-28" or 22 $\frac{1}{2}$ "-29"
- Shipping weight approximately 250 lbs.
- Standard width 24", optional 22", and 27"

Table Care

2.1 Cleaning your Table

Hill table upholstery may be cleaned with Hill Laboratories' Vinyl and Leather Cleaner or any household dishwashing liquid mixed with water. Hill also offers Protex™ Disinfectant Spray to protect against pathogens, including MRSA, HIV, Staph and the H1N1 Swine Flu Virus. Many stubborn stains can be removed by applying 91% rubbing alcohol (isopropyl alcohol) to the stain and wiping with a dry, soft, lint-free cotton cloth, towel or soft bristle brush.

Caution: These solvents are highly flammable; do not use near open flame or intense heat. Wear rubber gloves during all cleaning activities. When cleaning other parts of your table (besides upholstery) use only nonabrasive household detergents and water.

Cleaning the LCD Touchscreen

To clean your LCD Screen, DO NOT use common glass cleaners. Apply a light spray of distilled water or if necessary, a 50/50 mix of white vinegar and distilled water. Use a very soft cloth (cotton or micro-fiber) and apply it to the screen with gentle pressure. Do not press hard as this will damage the screen.

2.2 Caution and Symbol Explanation

Caution: Children should never be left alone in a room with the table but should always be accompanied by an adult.

Caution: Always unplug the table before performing any maintenance.

Caution: Check table once a year to make sure all internal and external bolts are secure.

Caution: The power cord should be located to avoid risk of tripping or having objects rolled over or placed on top of it. Damaged cords should be replaced with another of hospital grade.

Caution: Grounding reliability can only be achieved when connected to an equivalent receptacle marked hospital only or hospital grade.

Symbols - Each of the symbols below are used in your table labeling. An explanation of each is below.



Attention Symbol
consult accompanying
documents



Dangerous Voltage
Symbol



Type BF Applied
Part Symbol



Ground
Symbol



Alternating
Current
Symbol



Don't Touch
Symbol

Basic Table Operation

3.1 Preparing the Air-Flex for your patient

Plug your table into any 110 volt grounded outlet (or 220 volt - international).

Paper Roll - Feed the paper through the face cutout, around the paper bar (just below the cutout) and over the headpiece as shown. Close the paper cutter located on the side of the headpiece (photo 1) and tear off the excess.



Preparing the Air System

Press the green POWER button on the Control Panel to use the table's air-system. Each of the function buttons will light consecutively and then turn off. The table's air-compressor may also turn on to replenish the air-supply. The compressor will stop when the pressure reaches 90 lbs.* See 5.1, "Using Air-Drops" for air-feature instructions. *If the air-compressor runs for more than 2-3 minutes, call for service (see page 17).



Note: The Air-Flex is equipped with an Auto Shutdown mode which will power down the main control board if the table is inactive for 2 hours. Press the green power button to power the board back up.

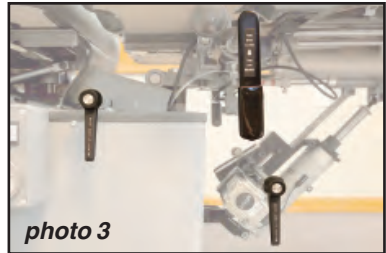

Note: It is very important that all three locking handles are firmly locked, pointing towards the floor before positioning your patient on the table (photo 3). This will prevent unwanted movement and potential injury to the patient. If your table has a Thoracic Breakaway, be sure it is also locked before positioning your patient (photo 4).

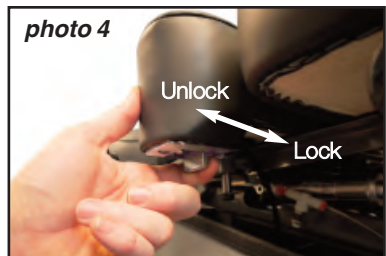

3.2 Height Pedal

The basic Air-Flex is equipped with a corded foot pedal (#9 under "Product Features") which controls the table height. Press the right side of the pedal to elevate; the left side to lower. For tables equipped with a rocker foot pedal (#10, page 2), height may be adjusted from either side of the table.

Auto-Touch Foot Pedal (option)

The Auto-Touch Foot Pedal option maintains upward or downward motion even after releasing the pedal. **To operate:**

- When the table is at minimum height, double-touch the “UP” arrow and release. The table will continue upward until you tap either side of the pedal again.
- When the table is at maximum height, double-touch the “DOWN” arrow and release. The table will continue downward until you tap either side of the pedal again.
- When the table is at any starting height in between, a single-touch up or down will start and stop the motion.

3.3 The Control Panel

The Air-Flex control panel (photo 5) has a power button, drop-selector buttons, and a breakaway, flexion and distraction button. After power, press in any order to activate the corresponding function. The Flexion, Distraction and Breakaway functions can be used in any order but must be used independently of one another. See section 5.1 “Using Air-Drops” for further instruction.

3.4 Manual Thoracic Release/Thoracic Air-Breakaway

Thoracic Release

To operate the Thoracic Release, pull the lever towards you while holding the cushion; adjust to the desired depth. Release the lever to lock the cushion.



Thoracic Air-Breakaway

For tables with a Thoracic Air-Breakaway, it is necessary to regulate the air-pressure before treating your patient. Follow these steps:

1. Select the ‘BRKY’ (breakaway) button on the main control panel (photo 5).
2. Unlock the thoracic breakaway switch by pulling toward you until it clicks (photo 4). This will allow the cushion to move freely up and down.
3. Press the right side of the Pressure Pedal (#13, page 2) to increase the air-pressure or left side to decrease in the thoracic section. Push down on the cushion as you add air to test for desired firmness.
4. Lock the cushion at any point by pushing the thoracic lock switch towards the table until it clicks.



photo 5

3.5 Basic Distraction

The following explains how to use the basic distraction feature on the Air-Flex. For detailed instruction on Auto-Distraction, see page 12.

1. Remove the Tiller Bar from its bracket between the ankle and pelvic cushion. (see page 2, #5).
2. Place the patient face down on the table with feet extended over the ankle rest.
3. Pull and hold the Slide-Out Ankle Support lock (photo 6) to extent the table length to fit the patient's height.
4. Secure the Ankle Straps around the patient's ankles.
5. Select the 'DIST' (distraction) button on the control panel.
6. Using the Pressure Pedal, increase the air-pressure to distract the patient.

Note: The speed rate of distraction can be adjusted by opening or closing the air-regulator under the thoracic cushion (photo 7).

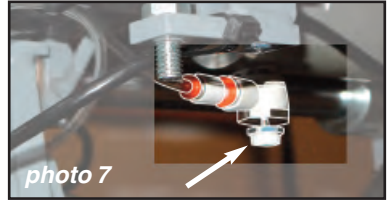

3.6 Basic Flexion (Balancing the Patient)

This section explains how to balance your patient and how to use basic flexion on the Air-Flex. For detailed instruction on the Auto-Flexion Feature, see page 10.

1. Be sure that the Flexion Lock is in the 6 o'clock, locked position (photo 8). Insert the Tiller Bar back into its bracket.
2. Select the 'FLEX' (flexion) button on Control Panel.
3. "Pre-pressure" the pelvic cushion to support the patient by pressing the pressure pedal. Ex: For a patient weighing 150-200 lbs., add pressure until the control panel gauge reads 40 – 50 lbs.



4. While holding the end of the table, disengage the Flexion Lock by turning the handle counter-clockwise—to the 4 o'clock position (A, photo 9). Now the patient is completely supported by air-pressure. Depending on the patient's weight, you may need to adjust the air-pressure to counter-balance the patient until only a small amount of force is required to flex

the patient. If the table does not spring back automatically to a horizontal, resting position, slightly increase the pressure.

5. For lateral movement, unlock the Lateral Locking Handle to the 4 o'clock position (B, photo 9).

Note: The table can be locked in any position along the flexion and/or lateral axis by turning the handle to the 6 o'clock position.

Using the Rotation Lock

The Rotation feature of the Air-Flex can be unlocked for free movement or locked at any angle. Unlike the flexion and lateral locks, the rotation lock is lever-controlled. A centering handle (A, photo 10) is also provided to locate and lock the pelvic cushion in the horizontal position.

4.1 Using the Rotation Feature

Turn the centering handle to the 4 o'clock position (A, photo 10). Unlock the rotation lever by pulling out until it clicks (B, photo 10) This will allow free movement in rotation.

To lock the rotation at any angle, simply push the rotation lever in towards the patient (B, photo 10).

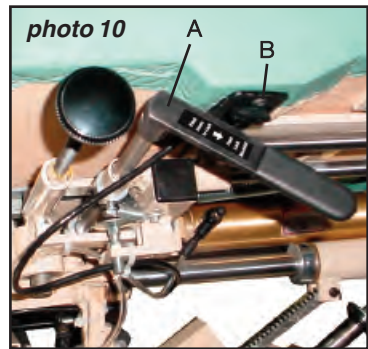

4.2 Returning the Rotation Feature to the Horizontal Position

1. Unlock lever (B, photo 11)
2. Manually move the pelvic section to a horizontal position.
3. Engage the centering handle by turning it to the 6 o'clock position (A, 11).

Note: If the centering handle will not lock, the pelvic cushion is not yet horizontal. Adjust the cushion until the handle locks.

4. Lock the rotation lever (B photo 11) by pushing it in, towards the table.

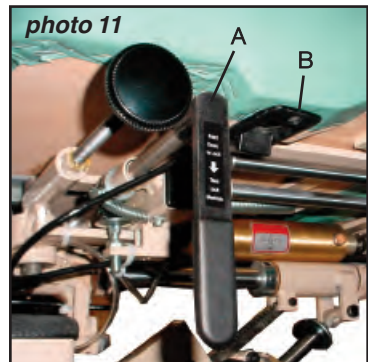

Important! The centering handle alone is not sufficient to secure the rotation function. Be sure to also lock the rotation lever to properly secure rotation.

Using Air-Drops

5.1 Drop Selector Switches

The Drop Selector Switches (photo 12) activate the table drops. You may select one or up to four drops simultaneously. Once selected, pressing the Pressure pedal (or optional foot strips) activates the drops. Once drops are discharged, pressing the pedal or foot strip again immediately reactivates them.



photo 12

Drop-Tension Control Knobs

The Drop-Tension Knobs are located on the left side of each drop (#15, page 2). Turn the knob clockwise to increase the firmness of the drop—counter clockwise to decrease.

Caution: Do not loosen Tension Knobs too far Adjusting the tension knobs out too far can cause the cervical (and pelvic) drops to malfunction. See The “Trouble Shooting” section on page 16 for more detail.

Headpieces

6.1 Tilting Headpiece

All Air-Flex models are equipped with a tilting headpiece. The lever for tilting is located under the front of the headpiece (A, photo 13). It controls the angle of tilt 30° positive or negative. Pull the lever to unlock; adjust the angle; release to lock.

6.2 Dual-Drop Headpiece

The Dual-Drop headpiece contains two drops—a drop-forward motion and a straight-down drop.

Important Note: Before changing any of the settings described in the following section, be sure the headpiece drop is discharged.

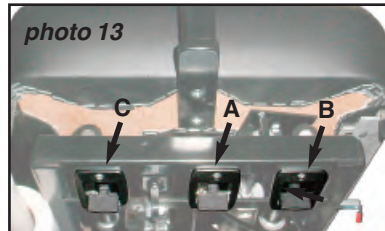

Drop-Forward Motion Headpiece

To use the Drop-Forward Motion of the headpiece, the setting lever should remain in the side channel of the setting mechanism as shown in photo 14. Be sure that the pin locks into the receiver behind it—otherwise, the drop will not work. For a manual drop, push up on the black cocking handle to engage. *For Air-Cervical Drop, see section 5.1.*

Straight-Down Drop Headpiece

To use the Straight-Down Drop action of the headpiece, pull the black setting lever out and turn it to the left so that it points straight down (photo 15). For a manual drop, push up on the black cocking handle to engage.

For Air-Cervical Drop, see section 5.1).

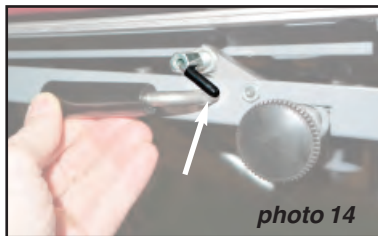

photo 14

6.3 Raised Headpiece

The Raised Headpiece allows the headpiece to rise up to 5" above the surface of the table. It is controlled by a lever in front of the head cushion (B, photo 13). Pull and hold the switch to adjust to the desired height; release to lock. To lower, apply gentle downward pressure to the thoracic end of the headpiece with one hand while pulling the lever to adjust.

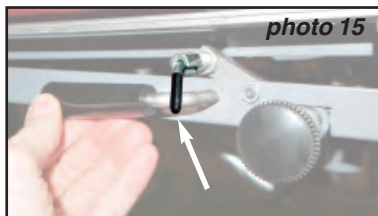

photo 15

6.4 Cervical Flexion/Distraction

The Cervical Flexion Headpiece includes the raised headpiece feature, occipital strap and the removable tiller bar.

Note: Cervical Flexion, Distraction and Lateral Motion (described below) can be used separately or in combination.

Cervical Flexion

Position the patient as shown in photo 16. Secure the occipital strap using the Velcro® connectors. Use the Tiller Bar to apply flexion.



photo 16

Cervical Distraction

Important: To use Manual Cervical Distraction you must first unlock the cushion for long axis motion by releasing the red lock pin (shown in photo 17). Pull and turn the lever to the left.

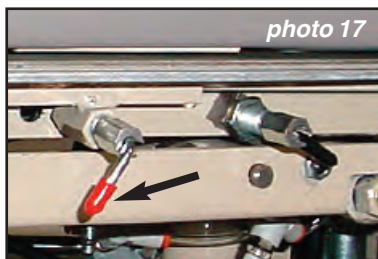

photo 17

Cervical Lateral Motion

The Cervical Flexion Headpiece includes lateral motion. To use lateral motion, locate the switch as shown in photo 18 (or C, photo 13). Pull the lever toward you to click

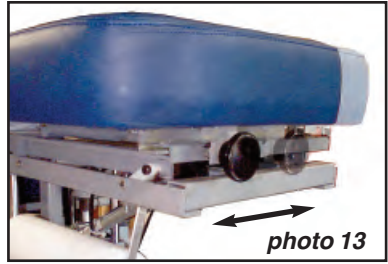

photo 18

and unlock. This will allow full-range lateral movement. The headpiece can also be locked at any angle in the lateral range.

6.5 Translation/CBP Headpiece

To use the translation headpiece, loosen the black knob in front of the headpiece by turning it counterclockwise. Push the cushion left or right to the desired position; turn clockwise to tighten the knob.



Instructions for the Auto-Flexion Option

Safety Caution: The moveable parts of the Auto-Flex feature can cause severe injury if handled improperly. Children should always be accompanied by an adult when in the room with the Air-Flex table.

7.1 The Auto-Flexion Touchscreen

The Auto-Flexion and Auto-Distracton features are both controlled by the touchscreen located on the pelvic section (See #7 under “Basic Table Functions”). You may easily toggle back and forth between the Auto-Flexion and Auto-Distracton display by pressing the “Dist/Flex” button respectively.

Auto-Flexion Touchscreen: Functions Defined

DEPTH - Defines the depth of the flexion stroke from 1-10

SPEED - Defines the speed of the flexion stroke from 1-12

HOLD - Defines the number of seconds the table “holds” at the set depth during each flexion cycle.

REST - Defines the number of seconds the table “rests” horizontally during each flexion cycle.

CYCLES - Defines the number of desired flexion cycles for treatment.

RUN - Starts treatment.

PAUSE - Pauses treatment (photo 19)

SLIDER - Sets the amount for any selected function.

DIST/FLEX - Toggles between flexion and distraction screens.



Press the Dist/Flex button to toggle between Flexion and Distraction screens.

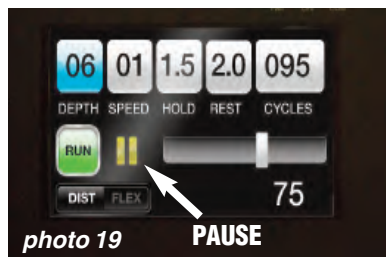

7.2 Switching to Auto-Flex

Important: Before proceeding with Auto-Flexion, read Section 3.6 on ‘Basic Flexion (Balancing the Patient)’.

It is very important that you become familiar with how to balance your patient BEFORE USING the Auto-Flex feature. THE PATIENT MUST BE SUPERVISED AT ALL TIMES DURING OPERATION.

1. Balance your patient by following steps 1 - 4 under section 3.6 “Basic Flexion”. Patient should start in a slightly flexed position.
2. To begin using the Auto-Flexion Touch Screen, press the “FLEX” button (Photo 21) on the main control panel. The touch screen should already be lit. By default, the touchscreen displays the settings from the last treatment. At start up, the touchscreen displays the Auto-Distraction screen (if so equipped). Press the “Dist/Flex” button to switch to the Auto-Flexion display.



photo 21

3. Set each of your touchscreen settings by touching each button in turn (buttons will turn blue when selected) and adjusting the slider for the desired setting.

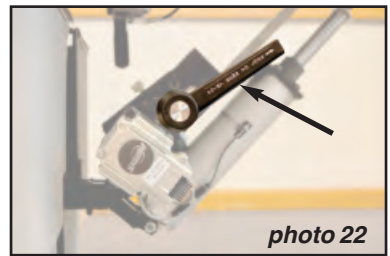

photo 22

Note: Adjusting the slider works best with the back of your finger or by simply tapping the slide bar at the desired point on the slide bar.

4. With settings selected, press “RUN” to start the treatment and move the flexion locking handle to the 1 o’clock position to engage the motor (Photo 22 - see note below). You will feel the handle move a cam into a lock position.

Note: Once the RUN Button is pressed, the operator has 30 seconds to engage the Auto-Flex motor by turning the flexion lock handle to the 1 o’clock position (photo 22). If not engaged within that time, the motor will shut off.

6. Press the yellow “PAUSE” button at any time to pause the treatment or to adjust your settings. Press PAUSE again to restart the treatment.
7. When the cycle time ends, the table will return to the rest/horizontal position. Before the patient exits the table, be sure the flexion, rotation and lateral lock handles are all turned to the 6 o’clock/locked position.

Note: When using distraction with Auto-Flex, flexion may not need to be as deep. Making a note of your settings for each patient makes it easy to duplicate treatment on subsequent visits.

Emergency Stopping for Auto-Distraction

To immediately stop an Auto-Distraction treatment at any time, press the STOP button on the touchscreen (right). The patient can also stop the treatment with the Stop-Treatment Patient Switch, shown right.



Instructions for the Auto-Distraction Option

To use distraction on the Air-Flex, first press the “DIST” button on the main control panel (photo 23). If this is the first treatment after table start-up, the touchscreen will automatically display the Auto-Distraction display. If you have already been using the touchscreen for Auto-Flexion, simply press the “Dist/Flex” button to enter Auto-Distraction.



NOTE: The Air-Flex can be locked in any flexion or lateral position during Auto-Distraction.

8.1 The Auto-Distraction Touchscreen

Auto-Distraction functions defined:

REST - Describes the duration of the treatment Rest Cycle in seconds. It is programmable from 5 to 60 seconds. During a treatment, the Rest Cycle will highlight and countdown the seconds remaining in that cycle.

PULL - Describes the duration of the treatment Pull Cycle in seconds. It is programmable from 5 seconds to 60 seconds. During a treatment, the Pull Cycle will highlight and countdown the seconds remaining in that cycle.

REST% - Rest % is used to calculate the Force during the Rest Cycle. It can be set to either 25% or 50%. For example, with a Force Setting of 40 lbs during the Pull Cycle, setting the Rest % to 25% will administer 10 lbs of Force during the Rest Cycle. A 50% setting yields 20 lbs. during Rest Cycle.

TIME - Describes the duration of the treatment time in minutes. The display will count down once the treatment has begun.

FORCE - The treatment Force is measured in U.S. pounds. It is programmable from 5 lbs-100 lbs for a Lumbar Treatment and 2 lbs-50 lbs for a Cervical

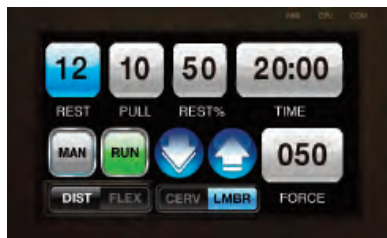

Treatment. During a treatment, the Force Setting will show the measured force in real-time.

ARROWS - The Up and Down Arrow Buttons are used to increase and decrease the treatment setting values. To edit a value, simply touch it and it will highlight in BLUE. Then use the arrow keys to enter the desired value.

LUMBAR/CERVICAL - The CERV/LMBR button indicates which distraction treatment type the table is currently set for.

If your table is equipped for both lumbar and cervical distraction, pressing the CERV/LMBR button will toggle between the two functions respectively. If your Air-Flex is only equipped with one auto-distraction option, you will not need to use this button.



MAN/AUTO - Manual/Automatic Button indicates which type of distraction mode (see below) you want to use. Press the button to toggle back and forth between MAN and AUTO.

RUN: Pressing RUN starts the treatment. While the system is in run mode the status display will flash "Run Mode Active" (see below).

8.2 Manual/Auto Mode

Manual Mode (MAN)

Manual Mode allows you to manually distract your patient using the pressure foot pedal. The Force Setting shows the pounds being administered to your patient once you release the foot pedal. This force will now be used as the peak force once the RUN button is pressed.

NOTE: For safety, Manual mode is not available while in Cervical Distraction.

Automatic Mode (AUTO)

Automatic Mode allows the table to automatically distract your patient with the amount of force you have set. The lumbar default setting is 50 lbs.; the cervical default setting is 10 lbs. Settings can also be changed before or during treatment using the up and down arrows.

Run Mode

Once the RUN button is pressed, the treatment begins and the status display flashes "Run Mode Active". While in Run Mode, the system cycles from Pull to Rest while displaying the actual Force being distributed in real-time in the FORCE display.

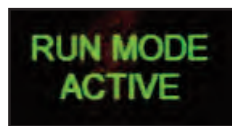

Stop Treatment

If the patient presses the hand-held patient cut-off switch (also see "Emergency Stopping, page 12), the treatment will end immediately and the status screen will display "Patient Cancelled Treatment". The system will vent and needs to be reset (see below).

If during a treatment the stop button is pressed (page 12), the treatment will end immediately and the status screen will display "Treatment Cancelled by Stopping". The system will vent and needs to be reset.

Following a successful treatment the timer resets and the status screen will read "Treatment Time Finished". The system will vent and needs to be reset.

PATIENT
CANCELLED
TREATMENT

TREATMENT
CANCELLED
BY STOPPING

TREATMENT
TIME
FINISHED

Reset Button

The reset button appears below the status display (see right). The reset button resets the air-system for another treatment and saves the current settings. **It is necessary to press the reset button at the end of each treatment.**



8.3 Cervical Auto-Distractor

Using Cervical Distraction

Insert the Cradle - First insert the cradle assembly into the receptacle at the end of the headpiece (A, photo 24).

Position the Patient - Gently insert the patient's neck into the cradle support with the insert pad facing the ceiling. Tighten the tension knob until the patient feels a slight inward pressure (A, photo 25). Secure the forehead straps with the Velcro connectors and tilt the headpiece about 5-10° (photo 24). Grasp the patient's ankles and gently pull towards the foot end of the table to ensure that the patient's occipital region rests upon the upper inside ridge of the cradle support (photo 25).

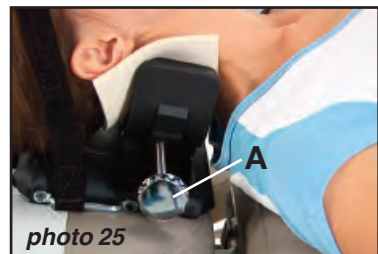
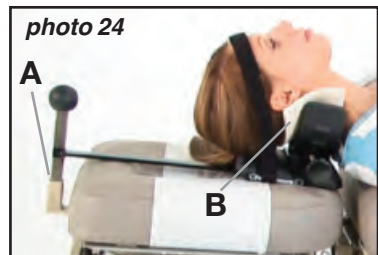

Unlock the Headpiece (Very Important!) - Pull and rotate the red pin located underneath the headpiece cushion by pulling the red handle out and left . This will unlock the headpiece for Auto-Distracton (see photo 17).

Enter Settings - Touch the cervical (CERV) button on the touchscreen and enter your treatment settings. Follow the same procedure used for Lumbar Distracton (See Section 8.1, “The Auto-Distracton Touchscreen”). Push the green run button to start the treatment.

Emergency Stop - Like Lumbar Distracton, Emergency Stop can be used at any time by you or your patient. See *“Emergency Stopping for Auto-Distracton”* under section 7.2.

Important Notes for Cervical Distracton

For Safety - No Foot-Pedal Control

Cervical Auto-Distracton is controlled by the touchscreen in the same way as Lumbar Auto-Distracton. Unlike Lumbar Distracton, Cervical Distracton cannot be controlled ‘manually’ with the foot pedal.

Screen Saver

When the touchscreen is not in use for several minutes, a screen saver will appear. Touching the screen will return to settings.

Maintenance

Regular Maintenance

Your Hill AFT is practically maintenance free. There is no lubrication of parts needed.

Trouble Shooting

Problem

**The Pelvic Cushion cocks but does not stay up.
The drop pin has come out of its track.**

To Fix:

1. Loosen the Pelvic Drop Tension Knob enough to rotate the drop pin (see "A" in drawing) so that the cross pin (B) faces and engages the bracket (C) as shown in the photo and drawing below. You may need to use a flat head screw driver to turn the pin from the bottom. Once the pin is turned into the bracket, retighten the Tension Knob.

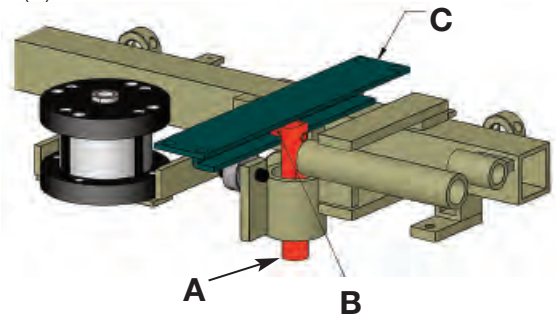
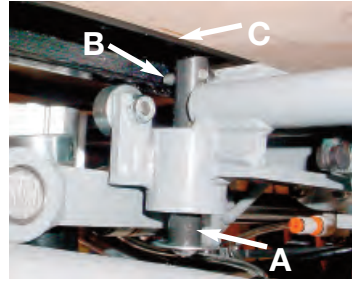

Problem

**The Cervical Cushion cocks up but does not stay up.
The drop pin has come out of its L-bracket.**

To Fix:

1. Loosen the Cervical Drop Tension Knob enough to rotate the drop pin (see "A" in photo) so that the spring pin (B) faces and engages the bracket (C) as shown in the photo. Once the pin is turned into the bracket, retighten the Tension Knob.

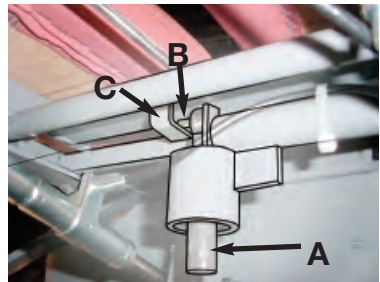

Problem

The main power board is turning off on it's own. This is likely the Auto-Shutdown mode operating normally.

When the Air-Flex is left inactive for 2 hours, the Auto-Shutdown mode will power the main control board down automatically.

To Fix:

Simply press the green power button.



Problem

The pelvic cushion bounces up and down when the Auto-Flex motor is engaged.

To Fix:

Increase the air-pressure by pressing the pressure foot pedal.



Additional service needed?

Contact your local dealer or reach us directly:

Phone: 1-877-445-5020

Fax: 610-647-6297

Email: Support@HillLabs.com

Technicians are available 9 am - 4 pm E.S.T., Monday - Friday.

Wiring Diagram - Air Flex, 24VDC, Part 1

Air System for all Air-Flex Models.

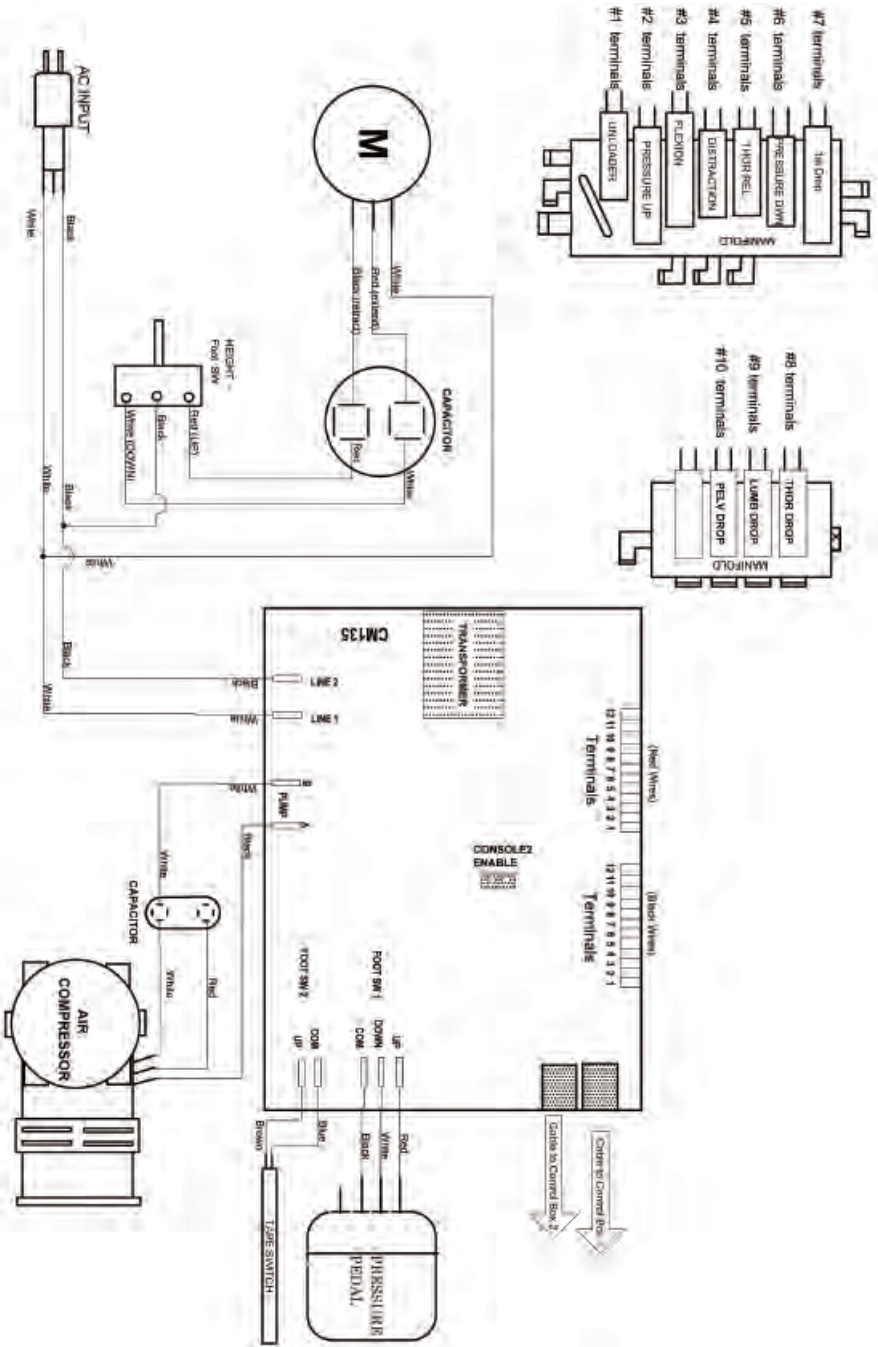

Wiring Diagram - Air Flex, 24VDC, Part 2

Air System for all Air-Flex Models.

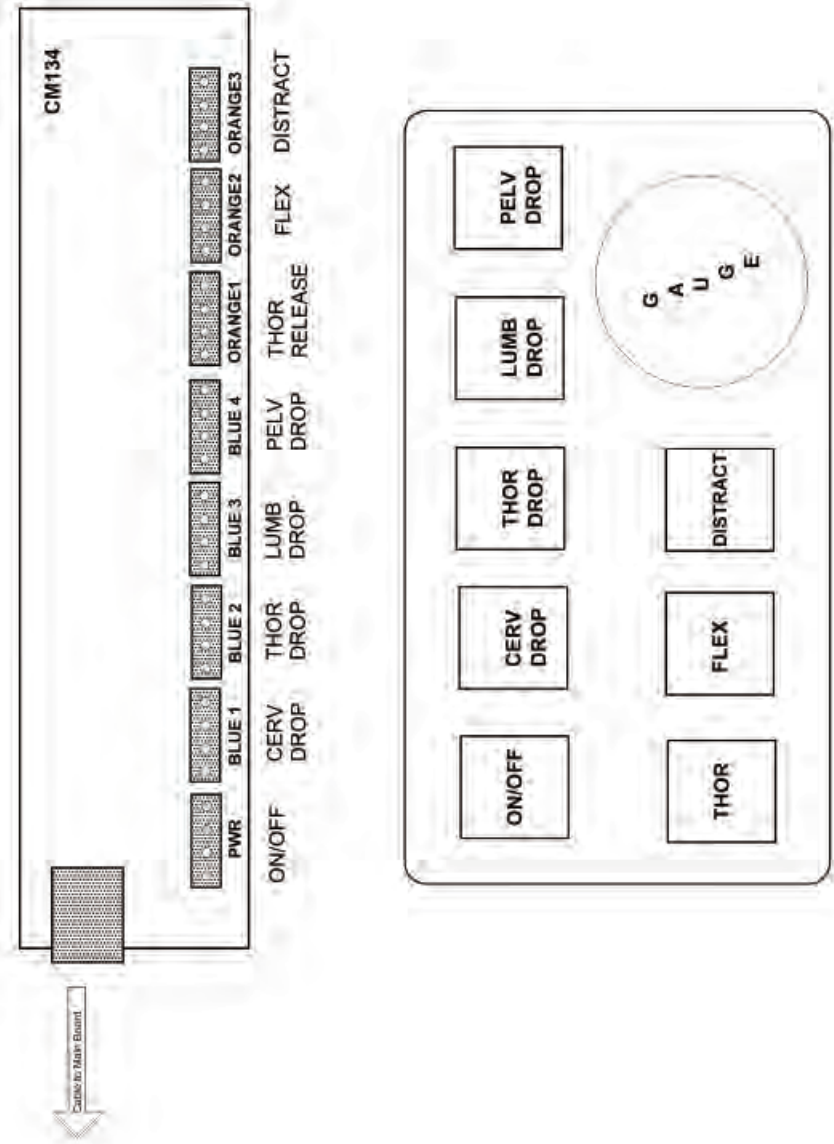

Wiring Diagram - Air Flex, 24VDC, Part 3

Height System for all Air-Flex Models.

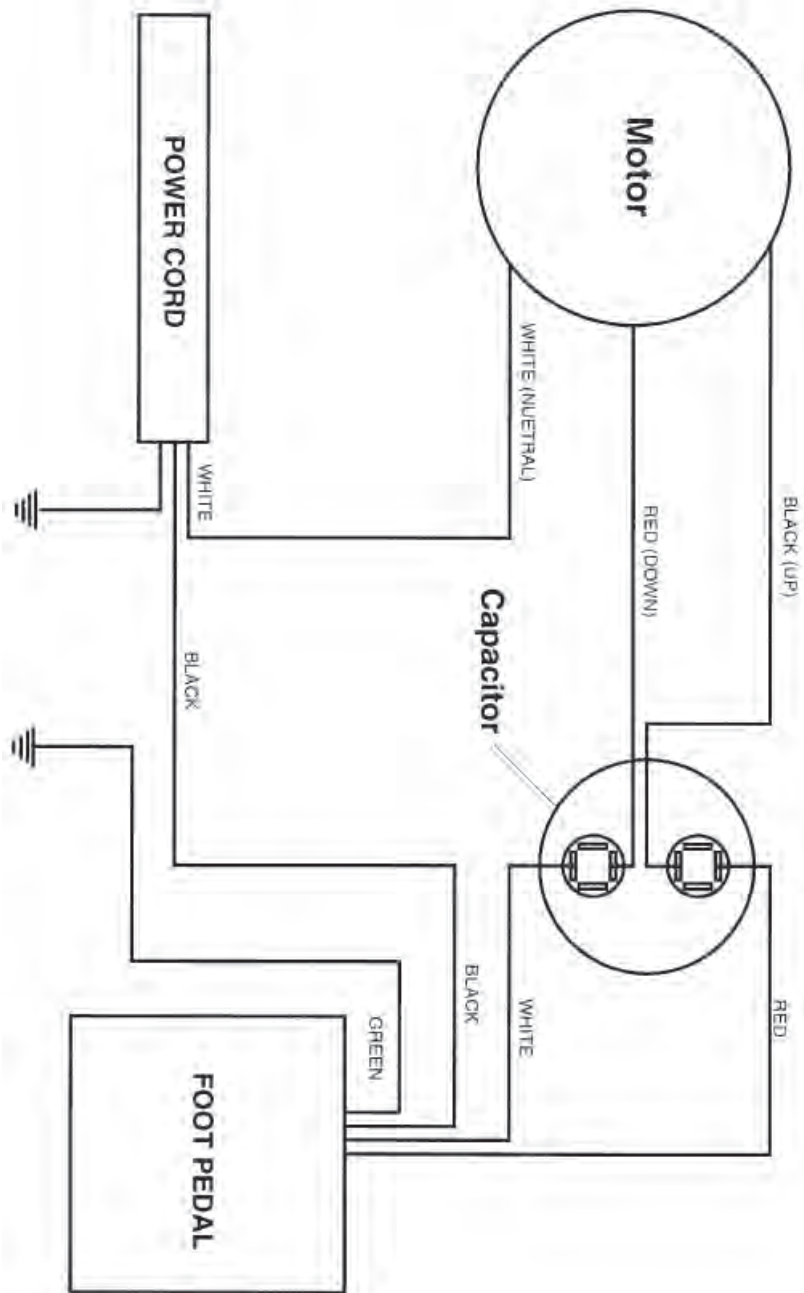

Index

A

Air-Compressor 4

Ankle Support

- Adjusting 2, 6

- Straps 2, 6

Armrests 2

Auto-Distracton 12-15

Auto-Flexion 10-12

Automatic Mode (also see "Run Mode") 13

Auto Shutdown 4,17

Auto-Touch Foot Pedal 5

B

Balancing the Patient 6

Basic Table Components 2

C

Cervical Distracton 14, 15

Cervical Flexion (see "Flexion") 9

Cleaning your table 3

Cautions and Symbols 3

Control Panel 4, 5, 6, 11, 12

D

Distracton

- Auto 12-14

- Basic 6

- Cervical 14, 15

Drops

- Cervical

- Operating 8, 9

- Not popping up 16

- Lumbar

- Operating 8

- Pelvic

- Operating 8

- Not popping up 16

- Thoracic

- Operating 8

E

Electrical specifications 2

Emergency Stop

- Patient Switch 12, 14

- Stop Button 12, 14

F

Flexion

- Auto 10-12

- Basic/Manual 6

- Cervical 9

Foot Pedal

- Auto-Touch 5

- Corded 2, 4

- Rocker 2, 4

Foot Strips 2, 8

H

Headpiece 2, 4, 8

- Air-Drop 8

- CBP/Translation 10

- Dual-Drop 8

- Flexion 9

- Lateral Adjustment 9

- Raised 9

- Tilting 8

- Translation/CBP 10

Height Range 2

Height Pedal 4

K

Knobs (See Tension Control Knobs)

L

Lateral Adjustment

- Cervical 9

- Pelvic 7

LCD (see "Touchscreen")

Lifting Capacity 2

Locking Mechanisms

- Flexion 4, 6

- Headpiece 8-10

- Lateral 7, 9

Index

L (continued)

- Rotation 2, 7
- Thoracic Breakaway 4, 5
- Thoracic Release 4, 5

M

- Maintenance 16
- Manual Flexion (See Flexion)

N

- Not Working (See Auto Shutdown)

O

- On/Off Switch (See Power Button)

P

- Paper Roll 4
- Patient Switch (see “Emergency Stop”)
- Pause Treatment 10, 11
- Power Button 4, 5, 17

R

- Raised Headpiece (See Headpieces)
- Reset Button 14
- Rocker Foot Pedal (See Foot Pedal)
- Rotation
 - Locking 7
 - Operating 7
 - Treating without 7
- Run Mode (Also see “Automatic Mode”) 13

S

- Service and Support See intro, “At Your Service”
- Specifications 2
- Speed Setting 10
- Stop Button (Also see “Emergency Stop”)

T

- Table Components 4
- Tension Control Knobs 2, 8

- Tiller Bar 2, 6, 9

- Timer 14

- Thoracic Breakaway 4, 5

- Thoracic Drop (see “Drops”)

- Thoracic Release 4, 5

- Touchscreen

- Cleaning 3
- Functions and Operation 10-14

- Trouble Shooting 16, 17

W

- Warranty See intro, “At Your Service”

- Wiring diagrams 18 - 20



Hill Laboratories
COMPANY

3 N. Bacton Hill Road, Frazer, PA 19355 • www.HillLabs.com
610-644-2867 • 1-877-445-5020 • Fax 610-647-6297

Congratulations!

And welcome to the Hill Laboratories family.

Hill Laboratories has been making quality a family business since 1945. Your new Air-Flex is built on an established Hill tradition of innovation and value. Our reputation rests on the confidence that *your* Hill Table will strengthen this legacy by providing you with solid, reliable service for many years to come.

At Your Service

The Hill Laboratories Guarantee.

Your Hill Laboratories table has been thoroughly tested and inspected before shipment. All parts are guaranteed against defect in materials for one full year from the date of purchase. During this period, any such defect will be remedied by Hill Laboratories or by a factory-authorized repair service at no charge. Tables damaged by mishandling or accident will be repaired at a reasonable charge. All correspondence should be directed to your local dealer, or when this is not possible, to Hill Laboratories directly.

For tables beyond the warranty period, our service technicians are standing by to serve you. They can be reached toll-free at 1-877-445-5020 from 9 am - 5 pm E.S.T., Monday through Friday. After hours, please leave your name, phone number and a brief description of your concern. Your call will be returned promptly the next business day.

We appreciate your business and your confidence in our products. Our aim is to provide you with excellent service and satisfaction for many years to come.

A handwritten signature in black ink that reads "Howard B. Hill". The signature is written in a cursive, flowing style.

President, Hill Laboratories

Hill Air-Flex Manual

Table of Contents

Product Features

Basic Table Components _____	1.1
Specifications _____	1.2

Table Care

Cleaning your Table _____	2.1
Caution and Symbol Explanation _____	2.2

Basic Table Operation

Preparing the Air-Flex for your Patient _____	3.1
Height Pedal _____	3.2
The Control Panel _____	3.3
Manual Thoracic Release/Thoracic Air-Breakaway _____	3.4
Basic Distraction _____	3.5
Basic Flexion (Balancing the Patient) _____	3.6

Using the Rotation Lock

Using the Rotation Feature _____	4.1
Returning the Rotation Feature to the Horizontal Position _____	4.2

Using Air-Drops

Drop Selector Switches _____	5.1
------------------------------	-----

Headpieces

Tilting Headpiece _____	6.1
Dual Drop Headpiece _____	6.2
Raised Headpiece _____	6.3
Cervical Flexion Headpiece _____	6.4
Translation/CBP Headpiece _____	6.5

Instructions for the Auto-Flexion Option

The Auto-Flexion Touchscreen _____	7.1
Switching to Auto-Flex _____	7.2

Instructions for the Auto-Distraction Option

The Auto-Distraction Touchscreen _____	8.1
Manual/Auto Mode _____	8.2
Cervical Auto-Distraction _____	8.3

Trouble Shooting _____	Pages 16-17
-------------------------------	-------------

Wiring Diagrams _____	Pages 18-20
------------------------------	-------------

Index of Terms _____	Pages 21-22
-----------------------------	-------------

Product Features

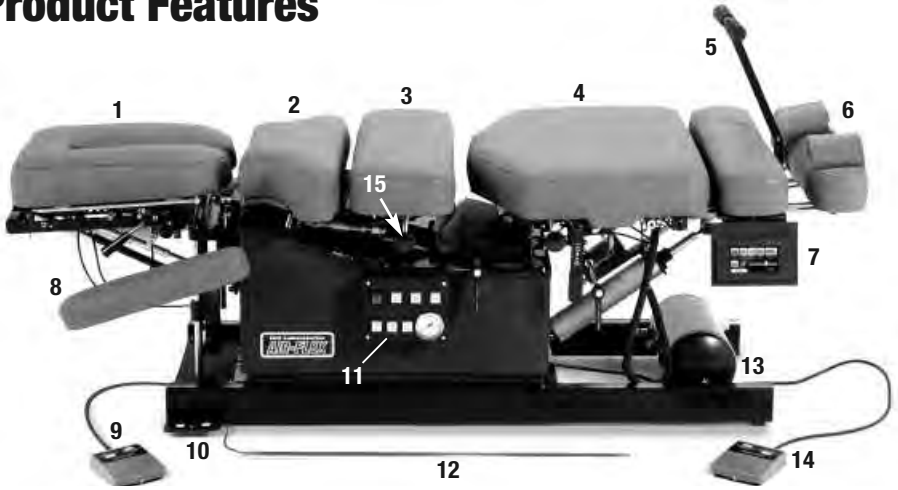

1.1 Basic Table Components and Options

1. Tilting Headpiece. May include several options
2. Thoracic Drop with Thoracic Release/Breakaway
3. Lumbar Drop
4. Pelvic Drop / Rotation and Lateral Flexion with locking mechanisms
5. Removable Flexion Tiller Bar
6. Slide-out Ankle Support with Ankle Harnesses
7. LCD Touchscreen Control (optional)
8. Armrest
9. Corded Height Pedal
10. Optional Rocker Foot Pedal
11. Power and Air-Drop Control Panel
12. Power Foot Strips for activating Air-Drops (optional)
13. Air Tank
14. Air-Pressure Foot Pedal
15. Drop-Tension Control Knobs

1.2 Specifications

- Electric requirement 60 Hz, 115 v~, 4.8 A or 220-50 cycle
- Lifting capacity - 450 pounds
- Acrylic thermo-plastic base
- Ultra-Cell® foam for comfort and shape retention
- Height Range - 21 $\frac{1}{2}$ "- 28" or 22 $\frac{1}{2}$ "- 29"
- Shipping weight approximately 250 lbs.
- Standard width 24", optional 22", and 27"

Table Care

2.1 Cleaning your Table

Hill table upholstery may be cleaned with Hill Laboratories' Vinyl and Leather Cleaner or any household dishwashing liquid mixed with water. Hill also offers Protex™ Disinfectant Spray to protect against pathogens, including MRSA, HIV, Staph and the H1N1 Swine Flu Virus. Many stubborn stains can be removed by applying 91% rubbing alcohol (isopropyl alcohol) to the stain and wiping with a dry, soft, lint-free cotton cloth, towel or soft bristle brush.

Caution: These solvents are highly flammable; do not use near open flame or intense heat. Wear rubber gloves during all cleaning activities. When cleaning other parts of your table (besides upholstery) use only nonabrasive household detergents and water.

Cleaning the LCD Touchscreen

To clean your LCD Screen, DO NOT use common glass cleaners. Apply a light spray of distilled water or if necessary, a 50/50 mix of white vinegar and distilled water. Use a very soft cloth (cotton or micro-fiber) and apply it to the screen with gentle pressure. Do not press hard as this will damage the screen.

2.2 Caution and Symbol Explanation

Caution: Children should never be left alone in a room with the table but should always be accompanied by an adult.

Caution: Always unplug the table before performing any maintenance.

Caution: Check table once a year to make sure all internal and external bolts are secure.

Caution: The power cord should be located to avoid risk of tripping or having objects rolled over or placed on top of it. Damaged cords should be replaced with another of hospital grade.

Caution: Grounding reliability can only be achieved when connected to an equivalent receptacle marked hospital only or hospital grade.

Symbols - Each of the symbols below are used in your table labeling. An explanation of each is below.



Attention Symbol
consult accompanying
documents



Dangerous Voltage
Symbol



Type BF Applied
Part Symbol



Ground
Symbol



Alternating
Current
Symbol



Don't Touch
Symbol

Basic Table Operation

3.1 Preparing the Air-Flex for your patient

Plug your table into any 110 volt grounded outlet (or 220 volt - international).

Paper Roll - Feed the paper through the face cutout, around the paper bar (just below the cutout) and over the headpiece as shown. Close the paper cutter located on the side of the headpiece (photo 1) and tear off the excess.

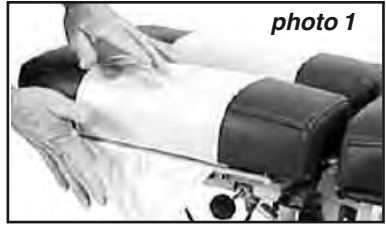

Preparing the Air System

Press the green POWER button on the Control Panel to use the table's air-system. Each of the function buttons will light consecutively and then turn off. The table's air-compressor may also turn on to replenish the air-supply. The compressor will stop when the pressure reaches 90 lbs.* See 5.1, "Using Air-Drops" for air-feature instructions. *If the air-compressor runs for more than 2-3 minutes, call for service (see page 17).



Note: The Air-Flex is equipped with an Auto Shutdown mode which will power down the main control board if the table is inactive for 2 hours. Press the green power button to power the board back up.

Note: It is very important that all three locking handles are firmly locked, pointing towards the floor before positioning your patient on the table (photo 3). This will prevent unwanted movement and potential injury to the patient. If your table has a Thoracic Breakaway, be sure it is also locked before positioning your patient (photo 4).

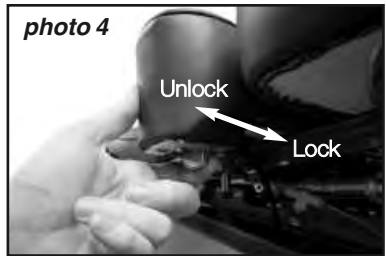

3.2 Height Pedal

The basic Air-Flex is equipped with a corded foot pedal (#9 under "Product Features") which controls the table height. Press the right side of the pedal to elevate; the left side to lower. For tables equipped with a rocker foot pedal (#10, page 2), height may be adjusted from either side of the table.

Auto-Touch Foot Pedal (option)

The Auto-Touch Foot Pedal option maintains upward or downward motion even after releasing the pedal. **To operate:**

- When the table is at minimum height, double-touch the “UP” arrow and release. The table will continue upward until you tap either side of the pedal again.
- When the table is at maximum height, double-touch the “DOWN” arrow and release. The table will continue downward until you tap either side of the pedal again.
- When the table is at any starting height in between, a single-touch up or down will start and stop the motion.

3.3 The Control Panel

The Air-Flex control panel (photo 5) has a power button, drop-selector buttons, and a breakaway, flexion and distraction button. After power, press in any order to activate the corresponding function. The Flexion, Distraction and Breakaway functions can be used in any order but must be used independently of one another. See section 5.1 “Using Air-Drops” for further instruction.

3.4 Manual Thoracic Release/Thoracic Air-Breakaway

Thoracic Release

To operate the Thoracic Release, pull the lever towards you while holding the cushion; adjust to the desired depth. Release the lever to lock the cushion.



Thoracic Air-Breakaway

For tables with a Thoracic Air-Breakaway, it is necessary to regulate the air-pressure before treating your patient. Follow these steps:

1. Select the ‘BRKY’ (breakaway) button on the main control panel (photo 5).
2. Unlock the thoracic breakaway switch by pulling toward you until it clicks (photo 4). This will allow the cushion to move freely up and down.
3. Press the right side of the Pressure Pedal (#13, page 2) to increase the air-pressure or left side to decrease in the thoracic section. Push down on the cushion as you add air to test for desired firmness.
4. Lock the cushion at any point by pushing the thoracic lock switch towards the table until it clicks.



3.5 Basic Distraction

The following explains how to use the basic distraction feature on the Air-Flex. For detailed instruction on Auto-Distraction, see page 12.

1. Remove the Tiller Bar from its bracket between the ankle and pelvic cushion. (see page 2, #5).
2. Place the patient face down on the table with feet extended over the ankle rest.
3. Pull and hold the Slide-Out Ankle Support lock (photo 6) to extent the table length to fit the patient's height.
4. Secure the Ankle Straps around the patient's ankles.
5. Select the 'DIST' (distraction) button on the control panel.
6. Using the Pressure Pedal, increase the air-pressure to distract the patient.

Note: The speed rate of distraction can be adjusted by opening or closing the air-regulator under the thoracic cushion (photo 7).

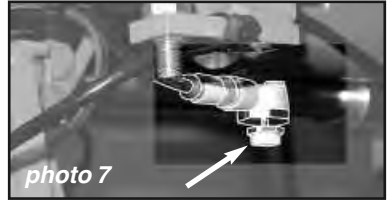

3.6 Basic Flexion (Balancing the Patient)

This section explains how to balance your patient and how to use basic flexion on the Air-Flex. For detailed instruction on the Auto-Flexion Feature, see page 10.

1. Be sure that the Flexion Lock is in the 6 o'clock, locked position (photo 8). Insert the Tiller Bar back into its bracket.
2. Select the 'FLEX' (flexion) button on Control Panel.
3. "Pre-pressure" the pelvic cushion to support the patient by pressing the pressure pedal. Ex: For a patient weighing 150-200 lbs., add pressure until the control panel gauge reads 40 – 50 lbs.
4. While holding the end of the table, disengage the Flexion Lock by turning the handle counter-clockwise—to the 4 o'clock position (A, photo 9). Now the patient is completely supported by air-pressure. Depending on the patient's weight, you may need to adjust the air-pressure to counter-balance the patient until only a small amount of force is required to flex



the patient. If the table does not spring back automatically to a horizontal, resting position, slightly increase the pressure.

5. For lateral movement, unlock the Lateral Locking Handle to the 4 o'clock position (B, photo 9).

Note: The table can be locked in any position along the flexion and/or lateral axis by turning the handle to the 6 o'clock position.

Using the Rotation Lock

The Rotation feature of the Air-Flex can be unlocked for free movement or locked at any angle. Unlike the flexion and lateral locks, the rotation lock is lever-controlled. A centering handle (A, photo 10) is also provided to locate and lock the pelvic cushion in the horizontal position.

4.1 Using the Rotation Feature

Turn the centering handle to the 4 o'clock position (A, photo 10). Unlock the rotation lever by pulling out until it clicks (B, photo 10) This will allow free movement in rotation.

To lock the rotation at any angle, simply push the rotation lever in towards the patient (B, photo 10).

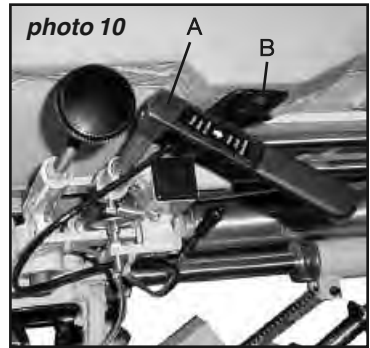

4.2 Returning the Rotation Feature to the Horizontal Position

1. Unlock lever (B, photo 11)
2. Manually move the pelvic section to a horizontal position.
3. Engage the centering handle by turning it to the 6 o'clock position (A, 11).

Note: If the centering handle will not lock, the pelvic cushion is not yet horizontal. Adjust the cushion until the handle locks.

4. Lock the rotation lever (B photo 11) by pushing it in, towards the table.

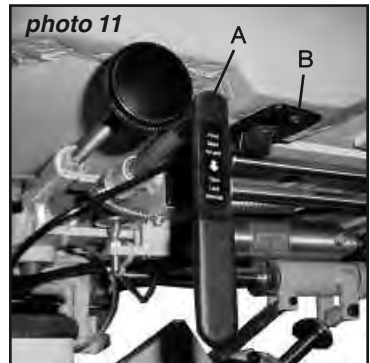

Important! The centering handle alone is not sufficient to secure the rotation function. Be sure to also lock the rotation lever to properly secure rotation.

Using Air-Drops

5.1 Drop Selector Switches

The Drop Selector Switches (photo 12) activate the table drops. You may select one or up to four drops simultaneously. Once selected, pressing the Pressure pedal (or optional foot strips) activates the drops. Once drops are discharged, pressing the pedal or foot strip again immediately reactivates them.



photo 12

Drop-Tension Control Knobs

The Drop-Tension Knobs are located on the left side of each drop (#15, page 2). Turn the knob clockwise to increase the firmness of the drop—counter clockwise to decrease.

Caution: Do not loosen Tension Knobs too far Adjusting the tension knobs out too far can cause the cervical (and pelvic) drops to malfunction. See The “Trouble Shooting” section on page 16 for more detail.

Headpieces

6.1 Tilting Headpiece

All Air-Flex models are equipped with a tilting headpiece. The lever for tilting is located under the front of the headpiece (A, photo 13). It controls the angle of tilt 30° positive or negative. Pull the lever to unlock; adjust the angle; release to lock.

6.2 Dual-Drop Headpiece

The Dual-Drop headpiece contains two drops—a drop-forward motion and a straight-down drop.

Important Note: Before changing any of the settings described in the following section, be sure the headpiece drop is discharged.

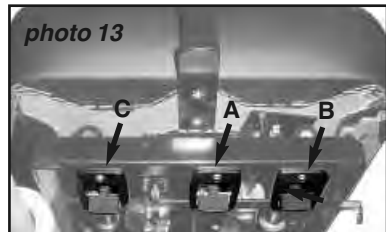

photo 13

Drop-Forward Motion Headpiece

To use the Drop-Forward Motion of the headpiece, the setting lever should remain in the side channel of the setting mechanism as shown in photo 14. Be sure that the pin locks into the receiver behind it—otherwise, the drop will not work. For a manual drop, push up on the black cocking handle to engage. *For Air-Cervical Drop, see section 5.1.*

Straight-Down Drop Headpiece

To use the Straight-Down Drop action of the headpiece, pull the black setting lever out and turn it to the left so that it points straight down (photo 15). For a manual drop, push up on the black cocking handle to engage.

For Air-Cervical Drop, see section 5.1).

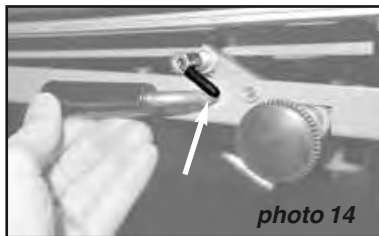

photo 14

6.3 Raised Headpiece

The Raised Headpiece allows the headpiece to rise up to 5" above the surface of the table. It is controlled by a lever in front of the head cushion (B, photo 13). Pull and hold the switch to adjust to the desired height; release to lock. To lower, apply gentle downward pressure to the thoracic end of the headpiece with one hand while pulling the lever to adjust.

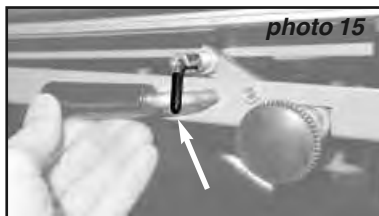

photo 15

6.4 Cervical Flexion/Distraction

The Cervical Flexion Headpiece includes the raised headpiece feature, occipital strap and the removable tiller bar.

Note: Cervical Flexion, Distraction and Lateral Motion (described below) can be used separately or in combination.



photo 16

Cervical Flexion

Position the patient as shown in photo 16. Secure the occipital strap using the Velcro® connectors. Use the Tiller Bar to apply flexion.

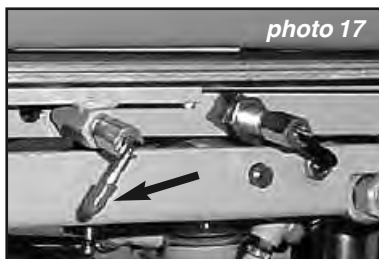

photo 17

Cervical Distraction

Important: To use Manual Cervical Distraction you must first unlock the cushion for long axis motion by releasing the red lock pin (shown in photo 17). Pull and turn the lever to the left.

Cervical Lateral Motion

The Cervical Flexion Headpiece includes lateral motion. To use lateral motion, locate the switch as shown in photo 18 (or C, photo 13). Pull the lever toward you to click

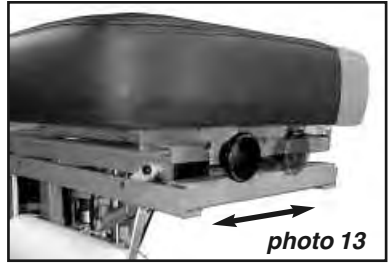

photo 18

and unlock. This will allow full-range lateral movement. The headpiece can also be locked at any angle in the lateral range.

6.5 Translation/CBP Headpiece

To use the translation headpiece, loosen the black knob in front of the headpiece by turning it counterclockwise. Push the cushion left or right to the desired position; turn clockwise to tighten the knob.



Instructions for the Auto-Flexion Option

Safety Caution: The moveable parts of the Auto-Flex feature can cause severe injury if handled improperly. Children should always be accompanied by an adult when in the room with the Air-Flex table.

7.1 The Auto-Flexion Touchscreen

The Auto-Flexion and Auto-Distraction features are both controlled by the touchscreen located on the pelvic section (See #7 under “Basic Table Functions”). You may easily toggle back and forth between the Auto-Flexion and Auto-Distraction display by pressing the “Dist/Flex” button respectively.

Auto-Flexion Touchscreen: Functions Defined

DEPTH - Defines the depth of the flexion stroke from 1-10

SPEED - Defines the speed of the flexion stroke from 1-12

HOLD - Defines the number of seconds the table “holds” at the set depth during each flexion cycle.

REST - Defines the number of seconds the table “rests” horizontally during each flexion cycle.

CYCLES - Defines the number of desired flexion cycles for treatment.

RUN - Starts treatment.

PAUSE - Pauses treatment (photo 19)

SLIDER - Sets the amount for any selected function.

DIST/FLEX - Toggles between flexion and distraction screens.



Press the Dist/Flex button to toggle between Flexion and Distraction screens.



7.2 Switching to Auto-Flex

Important: Before proceeding with Auto-Flexion, read Section 3.6 on ‘Basic Flexion (Balancing the Patient)’.

It is very important that you become familiar with how to balance your patient BEFORE USING the Auto-Flex feature. THE PATIENT MUST BE SUPERVISED AT ALL TIMES DURING OPERATION.

1. Balance your patient by following steps 1 - 4 under section 3.6 “Basic Flexion”. Patient should start in a slightly flexed position.
2. To begin using the Auto-Flexion Touch Screen, press the “FLEX” button (Photo 21) on the main control panel. The touch screen should already be lit. By default, the touchscreen displays the settings from the last treatment. At start up, the touchscreen displays the Auto-Distraction screen (if so equipped). Press the “Dist/Flex” button to switch to the Auto-Flexion display.



photo 21

3. Set each of your touchscreen settings by touching each button in turn (buttons will turn blue when selected) and adjusting the slider for the desired setting.

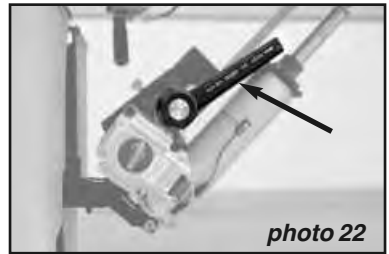

photo 22

Note: Adjusting the slider works best with the back of your finger or by simply tapping the slide bar at the desired point on the slide bar.

4. With settings selected, press “RUN” to start the treatment and move the flexion locking handle to the 1 o'clock position to engage the motor (Photo 22 - see note below). You will feel the handle move a cam into a lock position.

Note: Once the RUN Button is pressed, the operator has 30 seconds to engage the Auto-Flex motor by turning the flexion lock handle to the 1 o'clock position (photo 22). If not engaged within that time, the motor will shut off.

6. Press the yellow “PAUSE” button at any time to pause the treatment or to adjust your settings. Press PAUSE again to restart the treatment.
7. When the cycle time ends, the table will return to the rest/horizontal position. Before the patient exits the table, be sure the flexion, rotation and lateral lock handles are all turned to the 6 o'clock/locked position.

Note: When using distraction with Auto-Flex, flexion may not need to be as deep. Making a note of your settings for each patient makes it easy to duplicate treatment on subsequent visits.

Emergency Stopping for Auto-Distraction

To immediately stop an Auto-Distraction treatment at any time, press the STOP button on the touchscreen (right). The patient can also stop the treatment with the Stop-Treatment Patient Switch, shown right.



Instructions for the Auto-Distraction Option

To use distraction on the Air-Flex, first press the “DIST” button on the main control panel (photo 23). If this is the first treatment after table start-up, the touchscreen will automatically display the Auto-Distraction display. If you have already been using the touchscreen for Auto-Flexion, simply press the “Dist/Flex” button to enter Auto-Distraction.



photo 23

NOTE: The Air-Flex can be locked in any flexion or lateral position during Auto-Distraction.

8.1 The Auto-Distraction Touchscreen

Auto-Distraction functions defined:

REST - Describes the duration of the treatment Rest Cycle in seconds. It is programmable from 5 to 60 seconds. During a treatment, the Rest Cycle will highlight and countdown the seconds remaining in that cycle.



PULL - Describes the duration of the treatment Pull Cycle in seconds. It is programmable from 5 seconds to 60 seconds. During a treatment, the Pull Cycle will highlight and countdown the seconds remaining in that cycle.

REST% - Rest % is used to calculate the Force during the Rest Cycle. It can be set to either 25% or 50%. For example, with a Force Setting of 40 lbs during the Pull Cycle, setting the Rest % to 25% will administer 10 lbs of Force during the Rest Cycle. A 50% setting yields 20 lbs. during Rest Cycle.

TIME - Describes the duration of the treatment time in minutes. The display will count down once the treatment has begun.

FORCE - The treatment Force is measured in U.S. pounds. It is programmable from 5 lbs-100 lbs for a Lumbar Treatment and 2 lbs-50 lbs for a Cervical

Treatment. During a treatment, the Force Setting will show the measured force in real-time.

ARROWS - The Up and Down Arrow Buttons are used to increase and decrease the treatment setting values. To edit a value, simply touch it and it will highlight in BLUE. Then use the arrow keys to enter the desired value.

LUMBAR/CERVICAL - The CERV/LMBR button indicates which distraction treatment type the table is currently set for.

If your table is equipped for both lumbar and cervical distraction, pressing the CERV/LMBR button will toggle between the two functions respectively. If your Air-Flex is only equipped with one auto-distraction option, you will not need to use this button.



MAN/AUTO - Manual/Automatic Button indicates which type of distraction mode (see below) you want to use. Press the button to toggle back and forth between MAN and AUTO.

RUN: Pressing RUN starts the treatment. While the system is in run mode the status display will flash "Run Mode Active" (see below).

8.2 Manual/Auto Mode

Manual Mode (MAN)

Manual Mode allows you to manually distract your patient using the pressure foot pedal. The Force Setting shows the pounds being administered to your patient once you release the foot pedal. This force will now be used as the peak force once the RUN button is pressed.

NOTE: For safety, Manual mode is not available while in Cervical Distraction.

Automatic Mode (AUTO)

Automatic Mode allows the table to automatically distract your patient with the amount of force you have set. The lumbar default setting is 50 lbs.; the cervical default setting is 10 lbs. Settings can also be changed before or during treatment using the up and down arrows.

Run Mode

Once the RUN button is pressed, the treatment begins and the status display flashes "Run Mode Active". While in Run Mode, the system cycles from Pull to Rest while displaying the actual Force being distributed in real-time in the FORCE display.

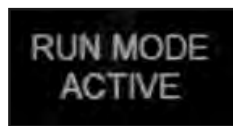

Stop Treatment

If the patient presses the hand-held patient cut-off switch (also see "Emergency Stopping, page 12), the treatment will end immediately and the status screen will display "Patient Cancelled Treatment". The system will vent and needs to be reset (see below).

If during a treatment the stop button is pressed (page 12), the treatment will end immediately and the status screen will display "Treatment Cancelled by Stopping". The system will vent and needs to be reset.

Following a successful treatment the timer resets and the status screen will read "Treatment Time Finished". The system will vent and needs to be reset.

PATIENT
CANCELLED
TREATMENT

TREATMENT
CANCELLED
BY STOPPING

TREATMENT
TIME
FINISHED

Reset Button

The reset button appears below the status display (see right). The reset button resets the air-system for another treatment and saves the current settings. **It is necessary to press the reset button at the end of each treatment.**



8.3 Cervical Auto-Distractor

Using Cervical Distraction

Insert the Cradle - First insert the cradle assembly into the receptacle at the end of the headpiece (A, photo 24).

Position the Patient - Gently insert the patient's neck into the cradle support with the insert pad facing the ceiling. Tighten the tension knob until the patient feels a slight inward pressure (A, photo 25). Secure the forehead straps with the Velcro connectors and tilt the headpiece about 5-10° (photo 24). Grasp the patient's ankles and gently pull towards the foot end of the table to ensure that the patient's occipital region rests upon the upper inside ridge of the cradle support (photo 25).

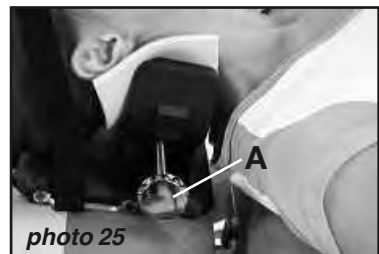
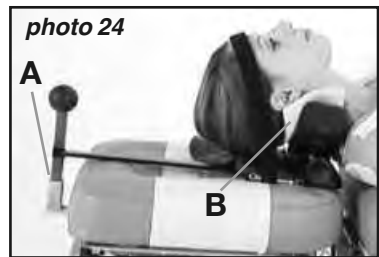

Unlock the Headpiece (Very Important!) - Pull and rotate the red pin located underneath the headpiece cushion by pulling the red handle out and left . This will unlock the headpiece for Auto-Distracton (see photo 17).

Enter Settings - Touch the cervical (CERV) button on the touchscreen and enter your treatment settings. Follow the same procedure used for Lumbar Distracton (See Section 8.1, “The Auto-Distracton Touchscreen”). Push the green run button to start the treatment.

Emergency Stop - Like Lumbar Distracton, Emergency Stop can be used at any time by you or your patient. See *“Emergency Stopping for Auto-Distracton” under section 7.2.*

Important Notes for Cervical Distracton

For Safety - No Foot-Pedal Control

Cervical Auto-Distracton is controlled by the touchscreen in the same way as Lumbar Auto-Distracton. Unlike Lumbar Distracton, Cervical Distracton cannot be controlled ‘manually’ with the foot pedal.

Screen Saver

When the touchscreen is not in use for several minutes, a screen saver will appear. Touching the screen will return to settings.

Maintenance

Regular Maintenance

Your Hill AFT is practically maintenance free. There is no lubrication of parts needed.

Trouble Shooting

Problem

**The Pelvic Cushion cocks but does not stay up.
The drop pin has come out of its track.**

To Fix:

1. Loosen the Pelvic Drop Tension Knob enough to rotate the drop pin (see "A" in drawing) so that the cross pin (B) faces and engages the bracket (C) as shown in the photo and drawing below. You may need to use a flat head screw driver to turn the pin from the bottom. Once the pin is turned into the bracket, retighten the Tension Knob.

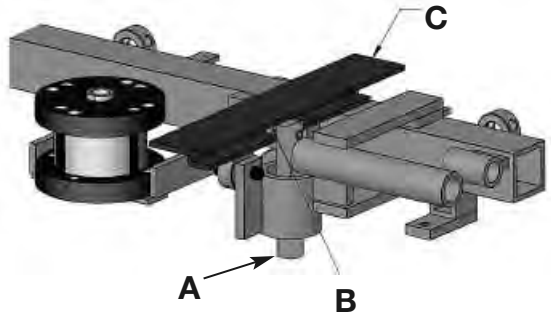
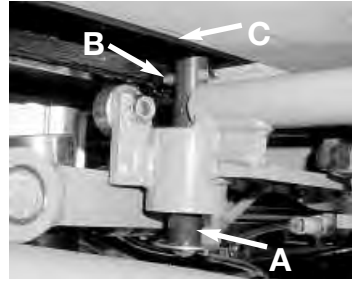

Problem

**The Cervical Cushion cocks up but does not stay up.
The drop pin has come out of its L-bracket.**

To Fix:

1. Loosen the Cervical Drop Tension Knob enough to rotate the drop pin (see "A" in photo) so that the spring pin (B) faces and engages the bracket (C) as shown in the photo. Once the pin is turned into the bracket, retighten the Tension Knob.

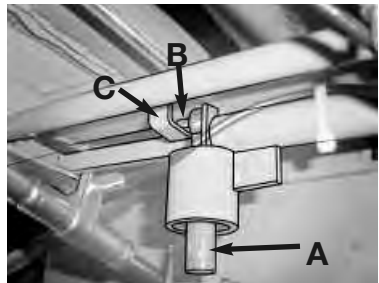

Problem

The main power board is turning off on it's own. This is likely the Auto-Shutdown mode operating normally.

When the Air-Flex is left inactive for 2 hours, the Auto-Shutdown mode will power the main control board down automatically.

To Fix:

Simply press the green power button.



Problem

The pelvic cushion bounces up and down when the Auto-Flex motor is engaged.

To Fix:

Increase the air-pressure by pressing the pressure foot pedal.



Additional service needed?

Contact your local dealer or reach us directly:

Phone: 1-877-445-5020

Fax: 610-647-6297

Email: Support@HillLabs.com

Technicians are available 9 am - 4 pm E.S.T., Monday - Friday.

Wiring Diagram - Air Flex, 24VDC, Part 1

Air System for all Air-Flex Models.

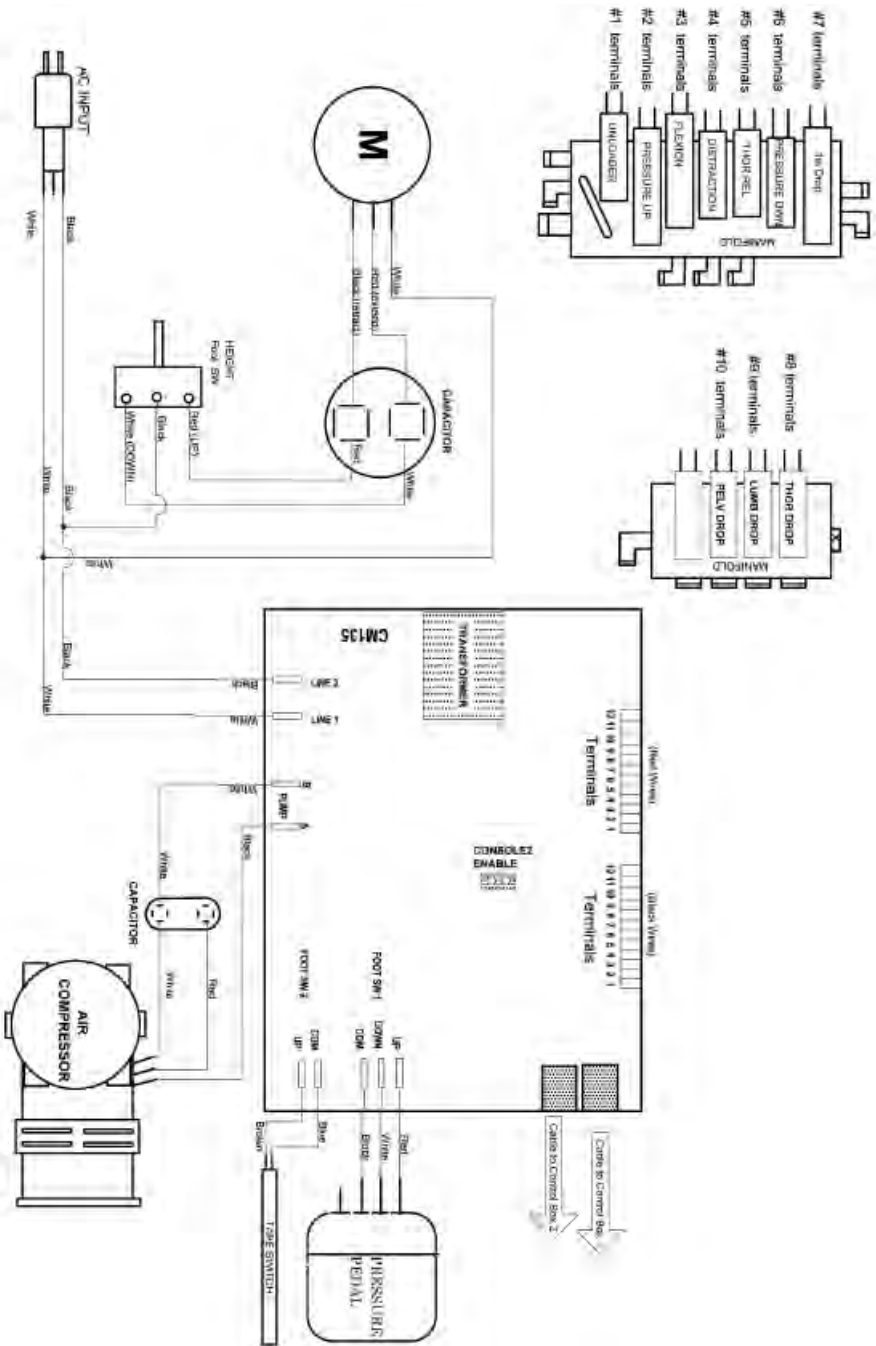

Wiring Diagram - Air Flex, 24VDC, Part 2

Air System for all Air-Flex Models.

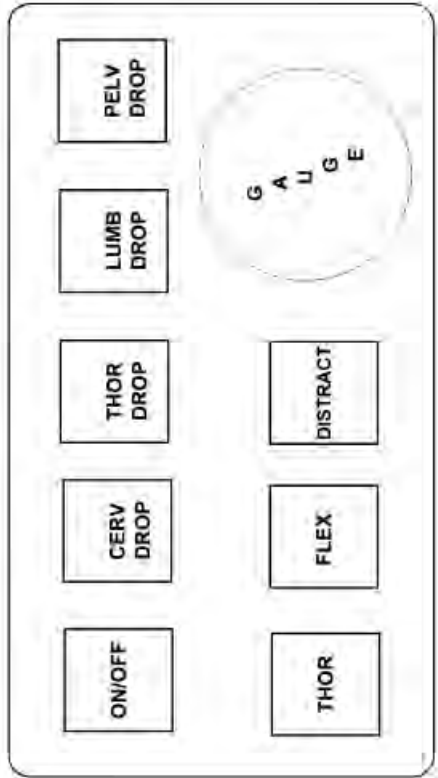
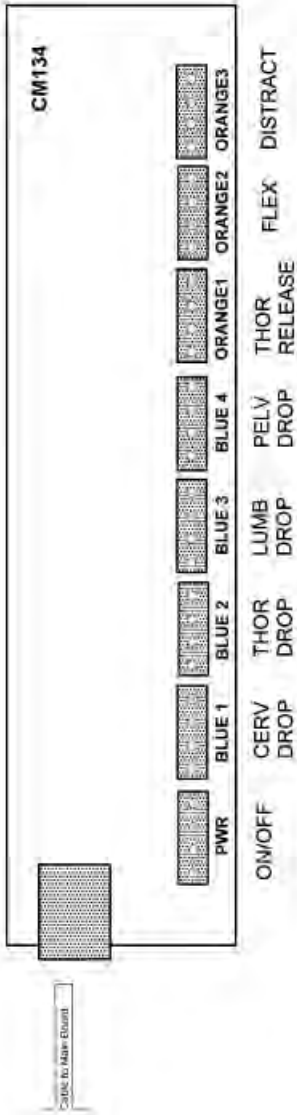

Wiring Diagram - Air Flex, 24VDC, Part 3

Height System for all Air-Flex Models.

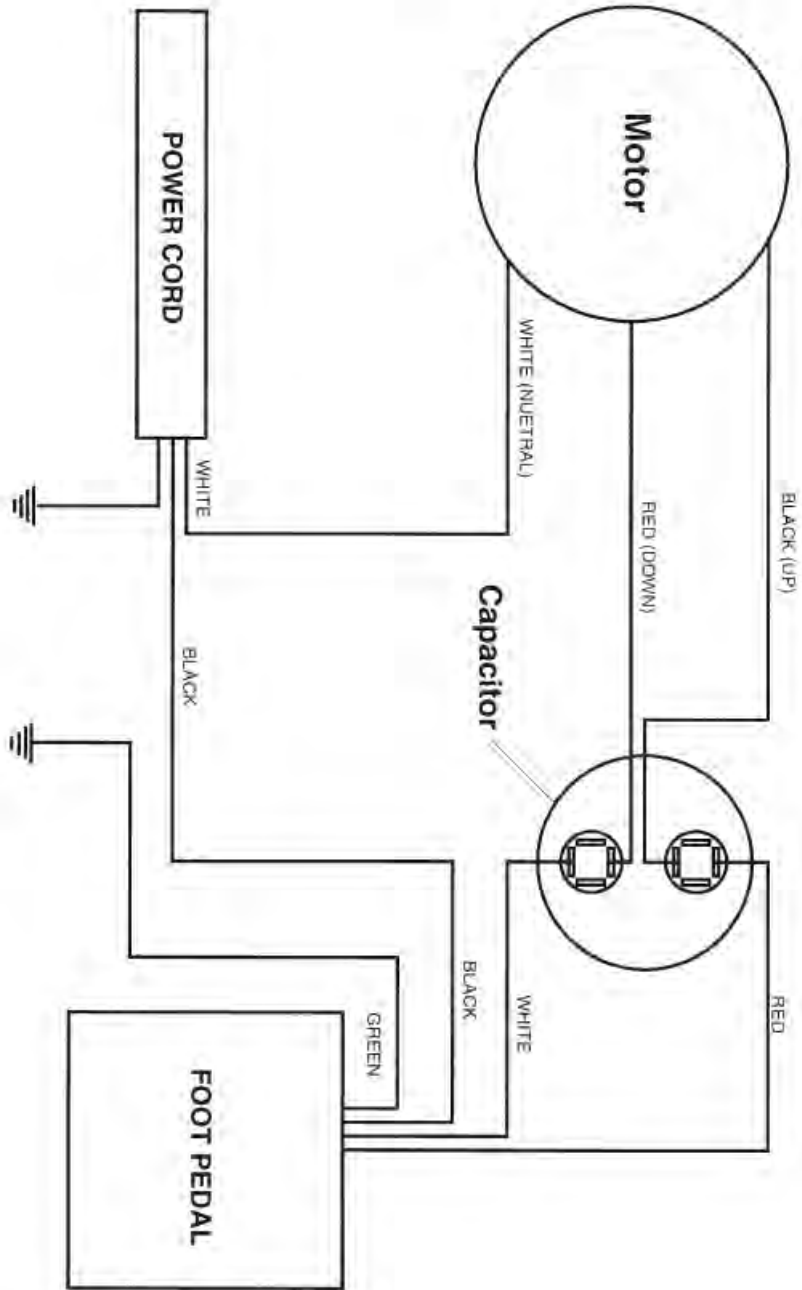

Index

A

Air-Compressor 4

Ankle Support

- Adjusting 2, 6

- Straps 2, 6

Armrests 2

Auto-Distracton 12-15

Auto-Flexion 10-12

Automatic Mode (also see "Run Mode") 13

Auto Shutdown 4,17

Auto-Touch Foot Pedal 5

B

Balancing the Patient 6

Basic Table Components 2

C

Cervical Distracton 14, 15

Cervical Flexion (see "Flexion") 9

Cleaning your table 3

Cautions and Symbols 3

Control Panel 4, 5, 6, 11, 12

D

Distracton

- Auto 12-14

- Basic 6

- Cervical 14, 15

Drops

- Cervical

- Operating 8, 9

- Not popping up 16

- Lumbar

- Operating 8

- Pelvic

- Operating 8

- Not popping up 16

- Thoracic

- Operating 8

E

Electrical specifications 2

Emergency Stop

- Patient Switch 12, 14

- Stop Button 12, 14

F

Flexion

- Auto 10-12

- Basic/Manual 6

- Cervical 9

Foot Pedal

- Auto-Touch 5

- Corded 2, 4

- Rocker 2, 4

Foot Strips 2, 8

H

Headpiece 2, 4, 8

- Air-Drop 8

- CBP/Translation 10

- Dual-Drop 8

- Flexion 9

- Lateral Adjustment 9

- Raised 9

- Tilting 8

- Translation/CBP 10

Height Range 2

Height Pedal 4

K

Knobs (See Tension Control Knobs)

L

Lateral Adjustment

- Cervical 9

- Pelvic 7

LCD (see "Touchscreen")

Lifting Capacity 2

Locking Mechanisms

- Flexion 4, 6

- Headpiece 8-10

- Lateral 7, 9

Index

L (continued)

- Rotation 2, 7
- Thoracic Breakaway 4, 5
- Thoracic Release 4, 5

M

- Maintenance 16
- Manual Flexion (See Flexion)

N

- Not Working (See Auto Shutdown)

O

- On/Off Switch (See Power Button)

P

- Paper Roll 4
- Patient Switch (see “Emergency Stop”)
- Pause Treatment 10, 11
- Power Button 4, 5, 17

R

- Raised Headpiece (See Headpieces)
- Reset Button 14
- Rocker Foot Pedal (See Foot Pedal)
- Rotation
 - Locking 7
 - Operating 7
 - Treating without 7
- Run Mode (Also see “Automatic Mode”) 13

S

- Service and Support See intro, “At Your Service”
- Specifications 2
- Speed Setting 10
- Stop Button (Also see “Emergency Stop”)

T

- Table Components 4
- Tension Control Knobs 2, 8

- Tiller Bar 2, 6, 9

- Timer 14

- Thoracic Breakaway 4, 5

- Thoracic Drop (see “Drops”)

- Thoracic Release 4, 5

- Touchscreen

- Cleaning 3
- Functions and Operation 10-14

- Trouble Shooting 16, 17

W

- Warranty See intro, “At Your Service”

- Wiring diagrams 18 - 20



Hill Laboratories
COMPANY

3 N. Bacton Hill Road, Frazer, PA 19355 • www.HillLabs.com
610-644-2867 • 1-877-445-5020 • Fax 610-647-6297